

ROBOTICA



PROBOTS

LAVADORA

500 PIEZAS
+ E-BRICK
+ 2 MOTORES
Q-X4000



1

2

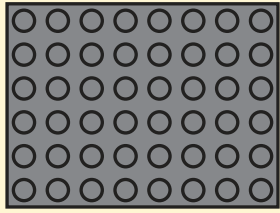

5

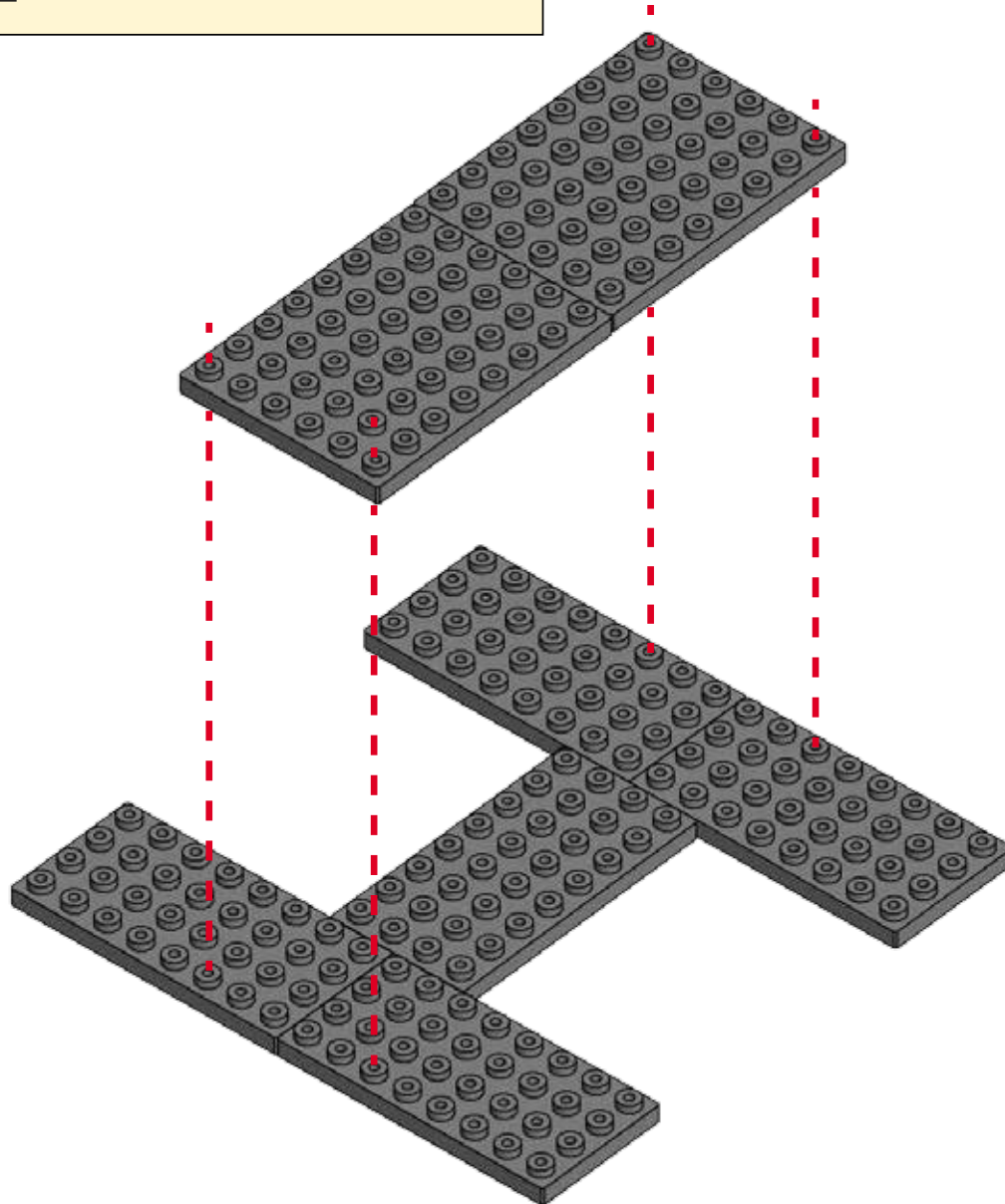
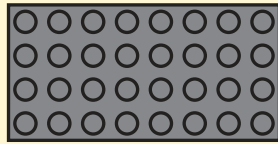

2

4



4

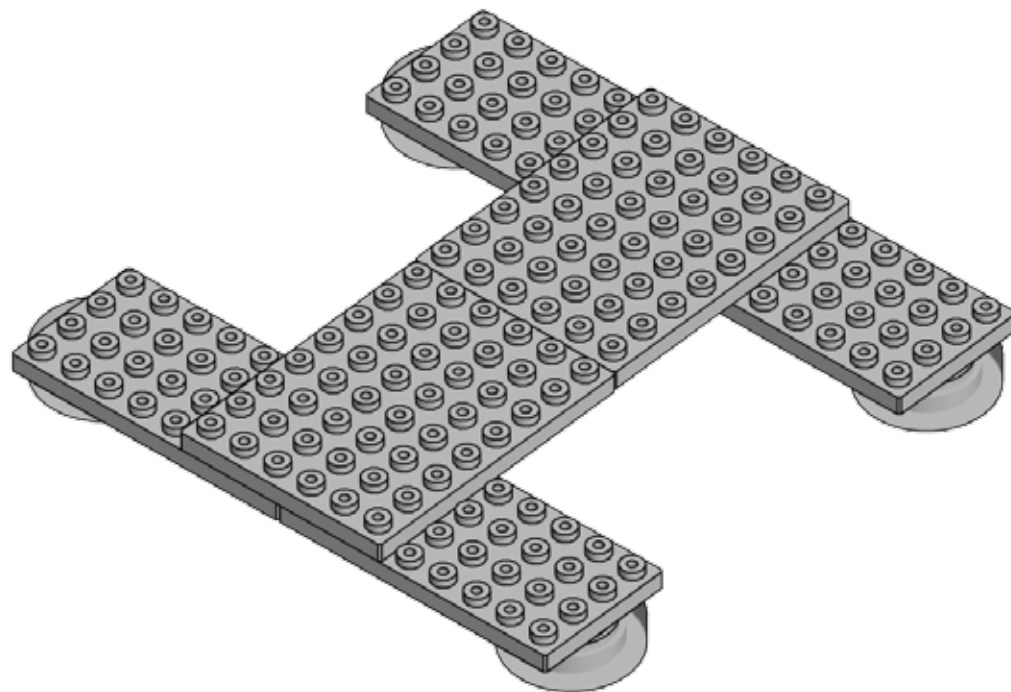
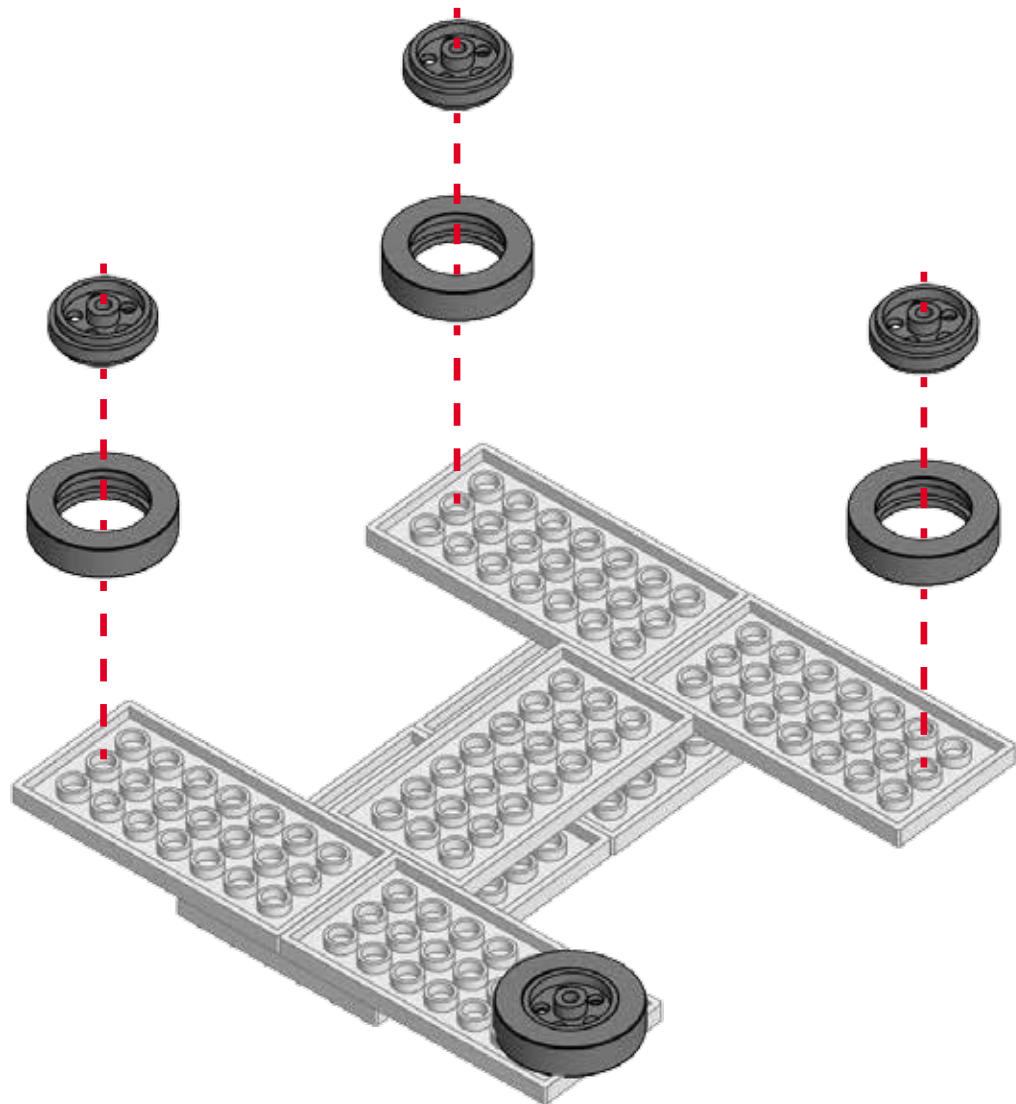

3

4



1

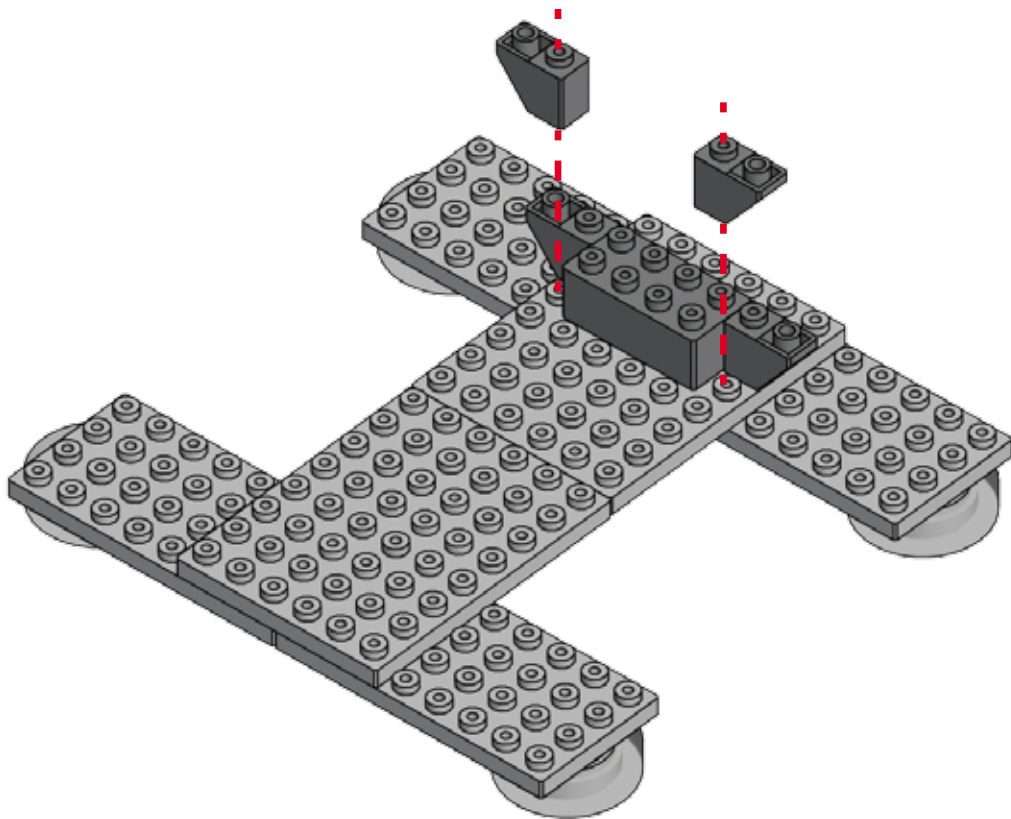
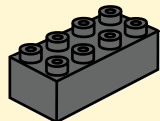

4

4



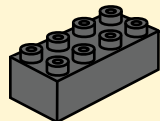

1

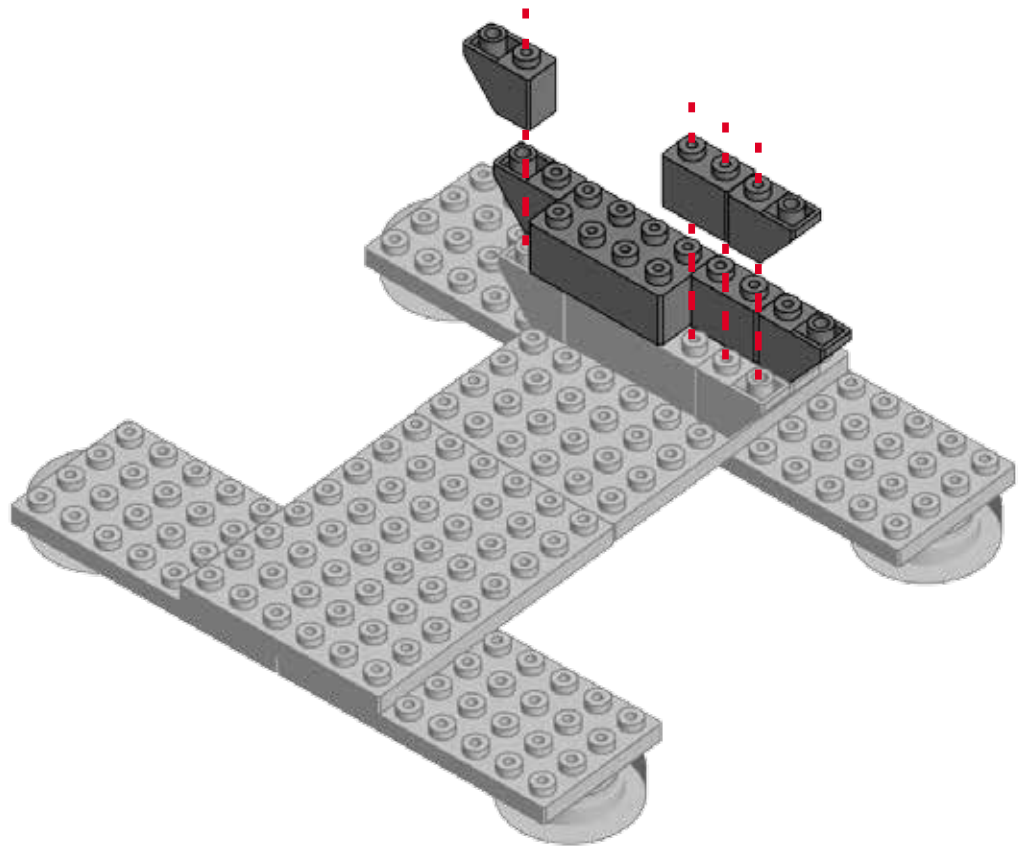

2



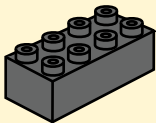

5

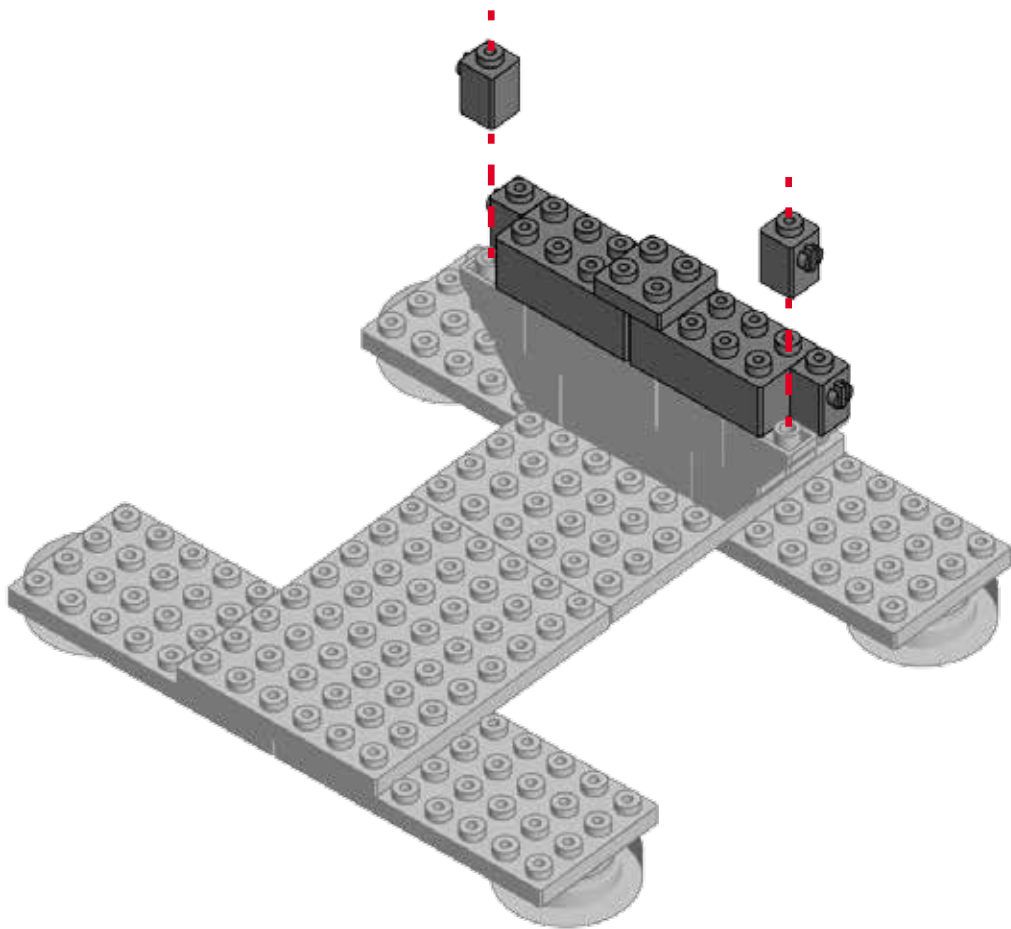
2  4  1 

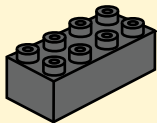
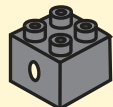

6

3  1  2 
2 

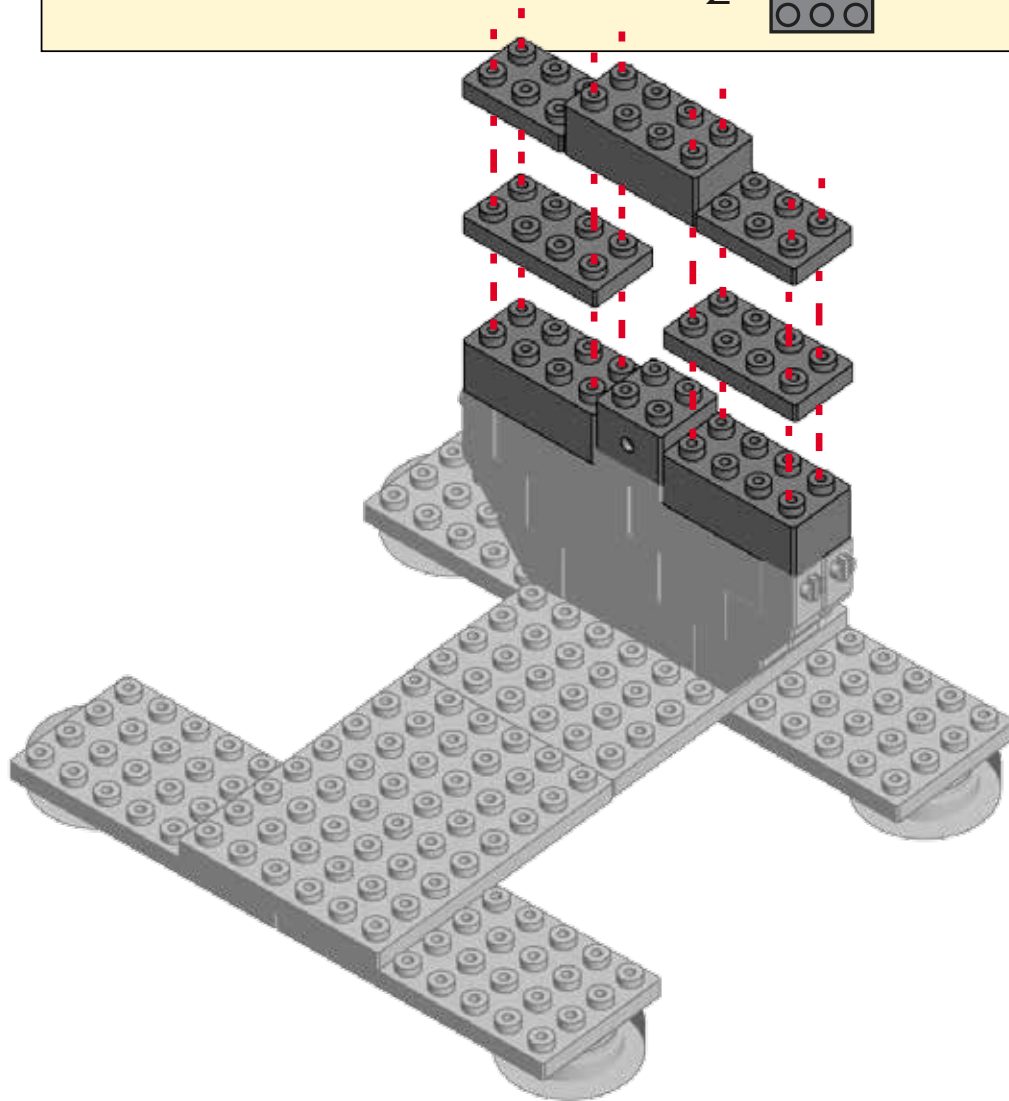

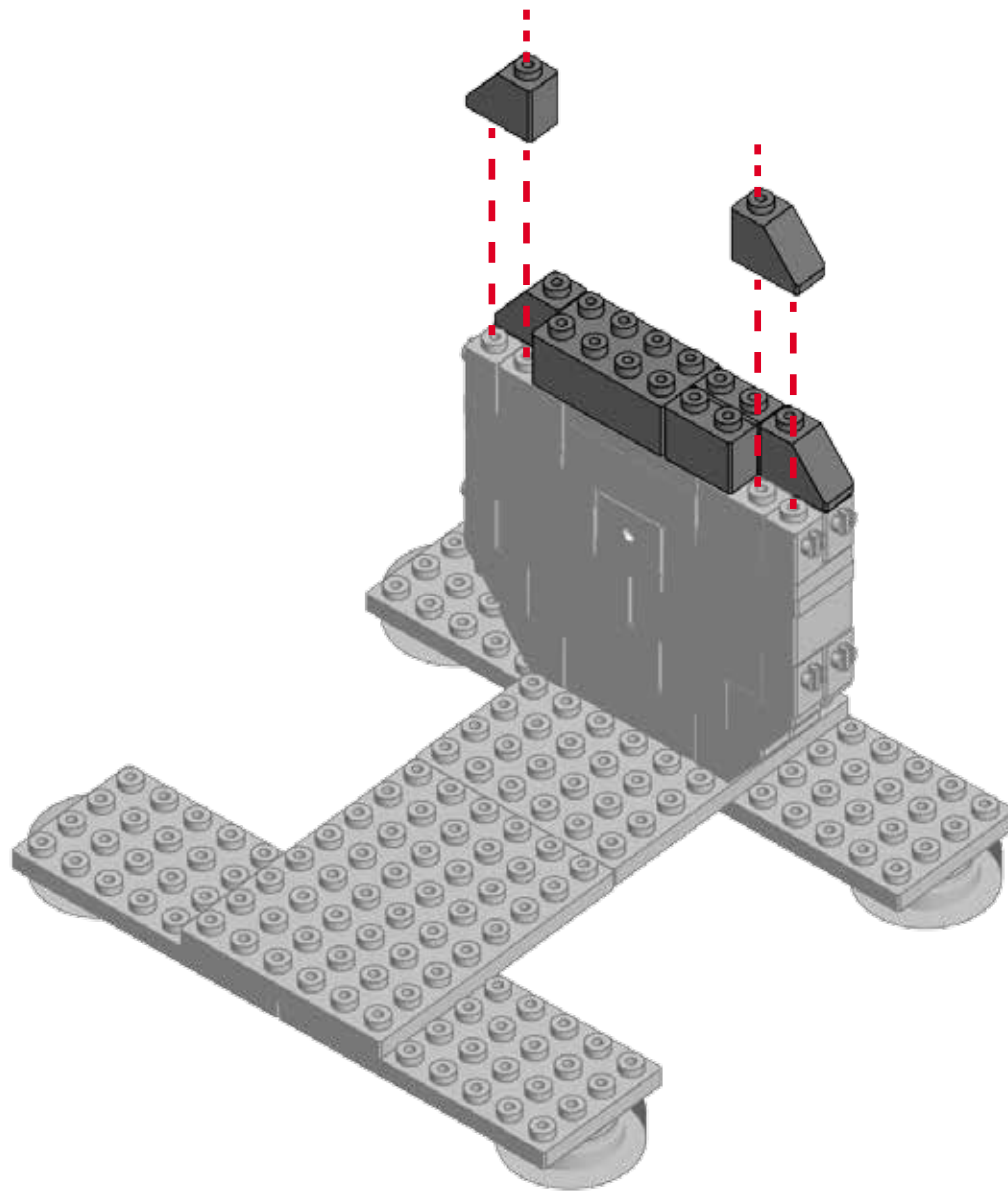
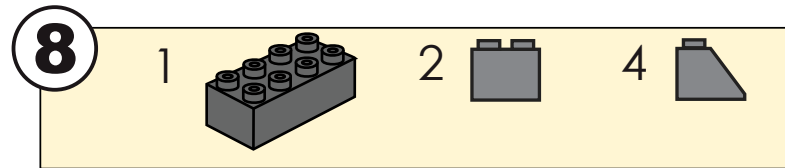
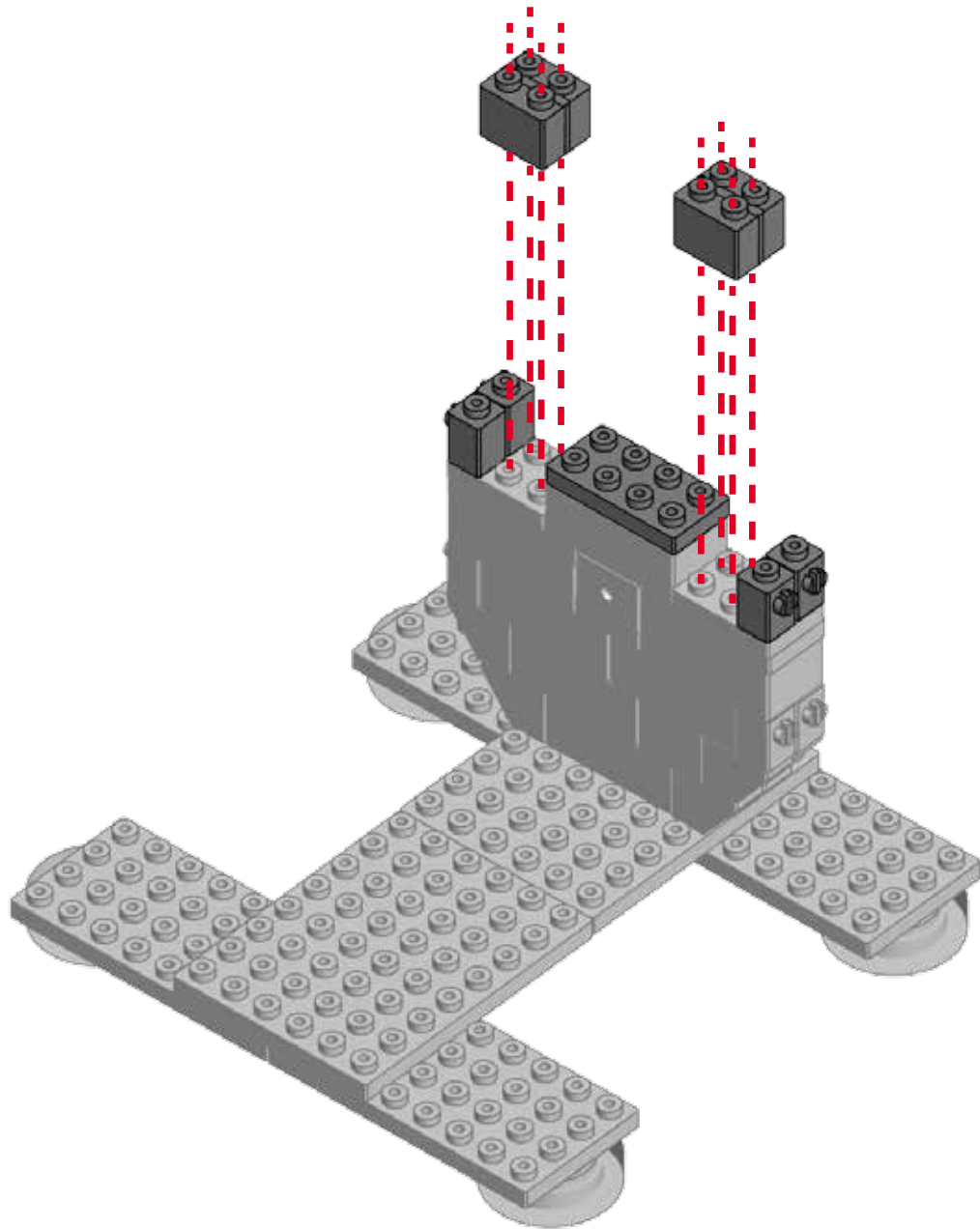
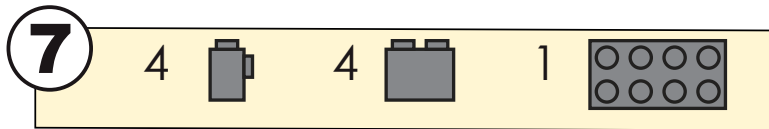

9

1

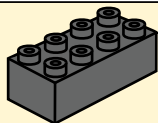

4

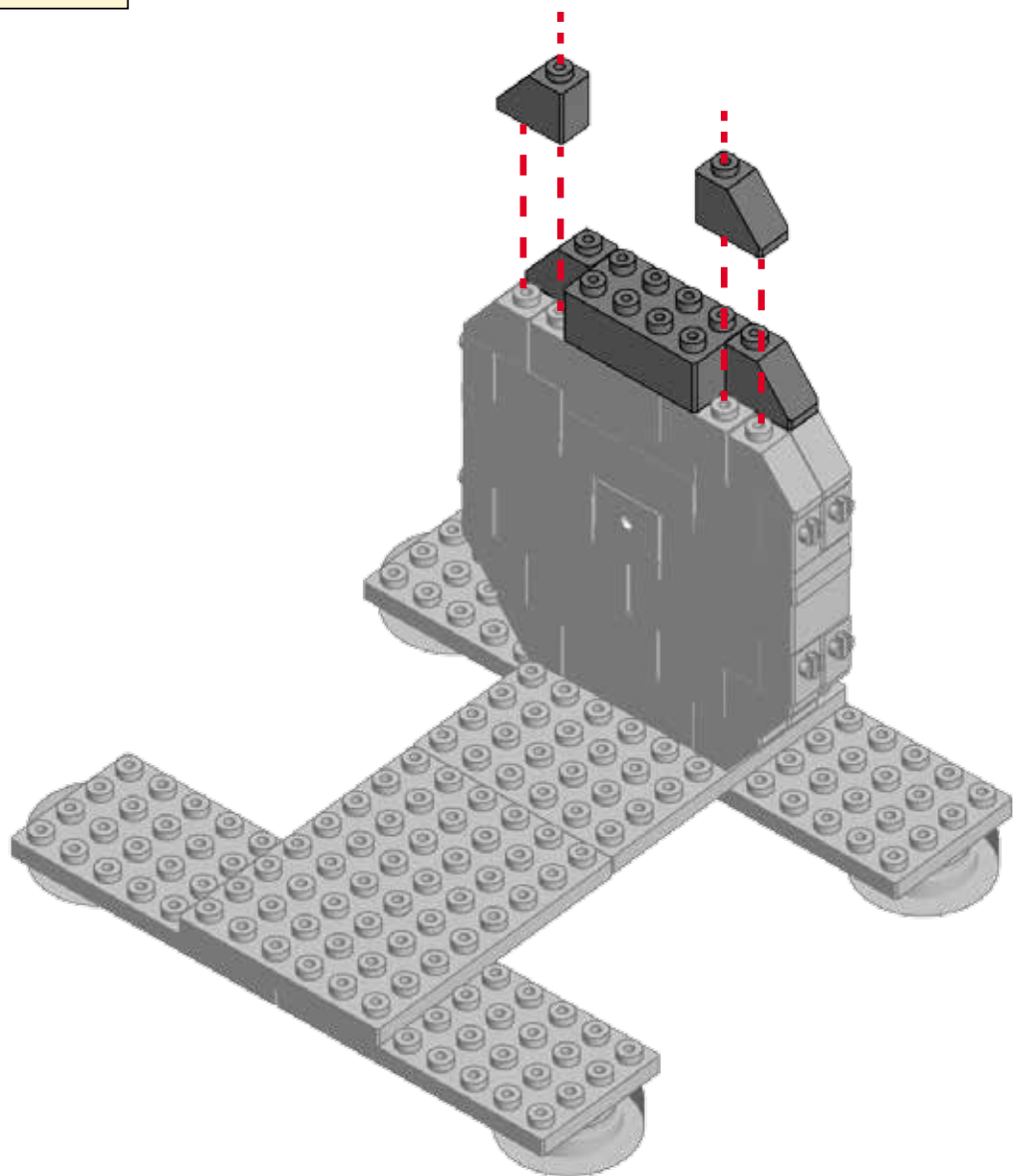

10

4

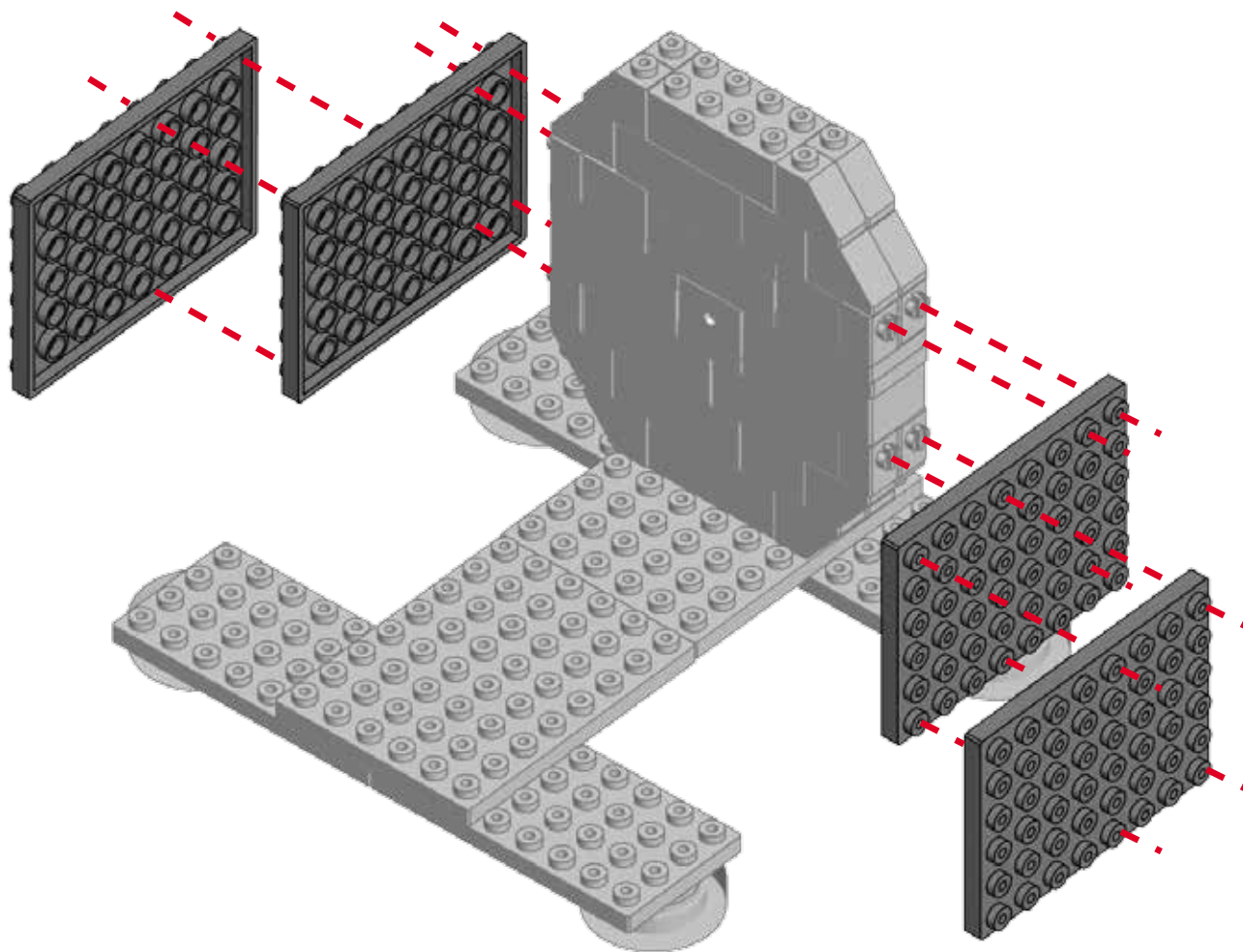
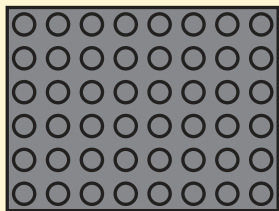

11

2

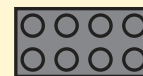

2

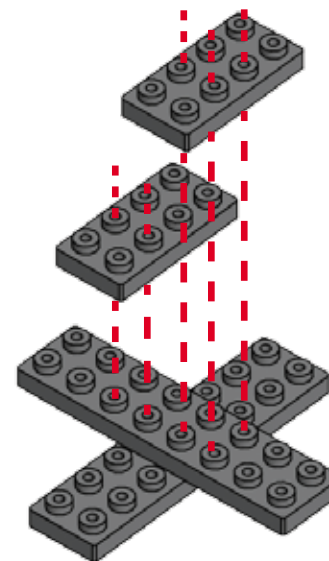
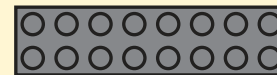

12

2



1

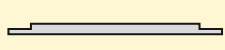

4

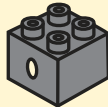

1

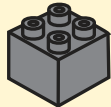

8

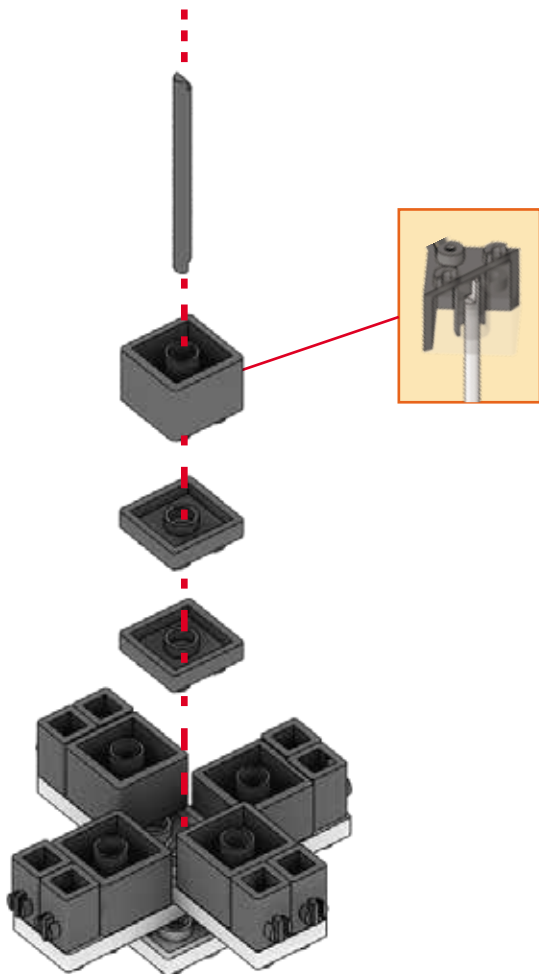

13

4



4

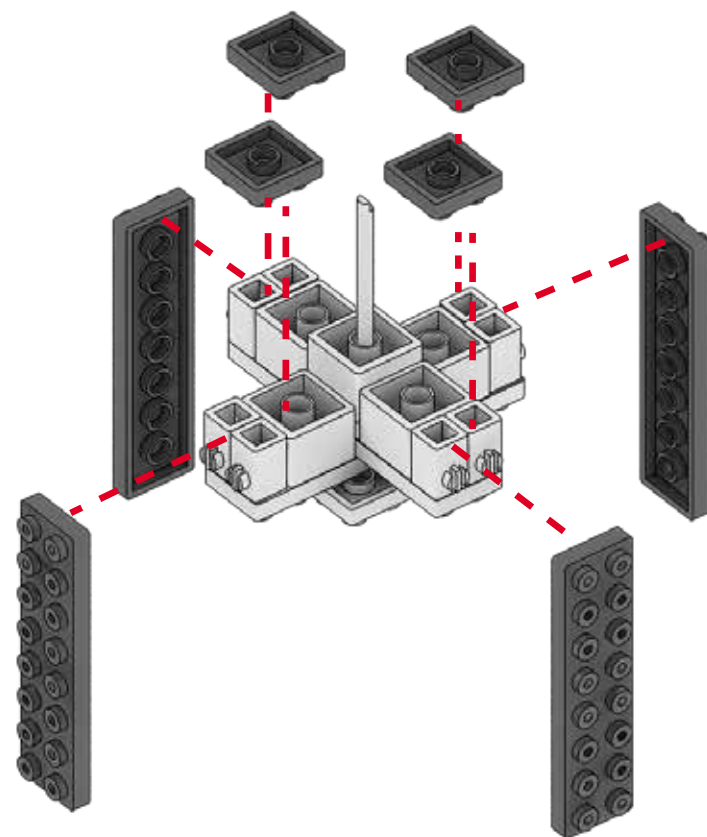
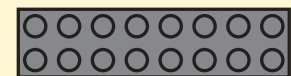

14

1

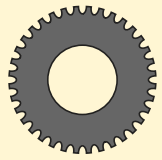

1



10

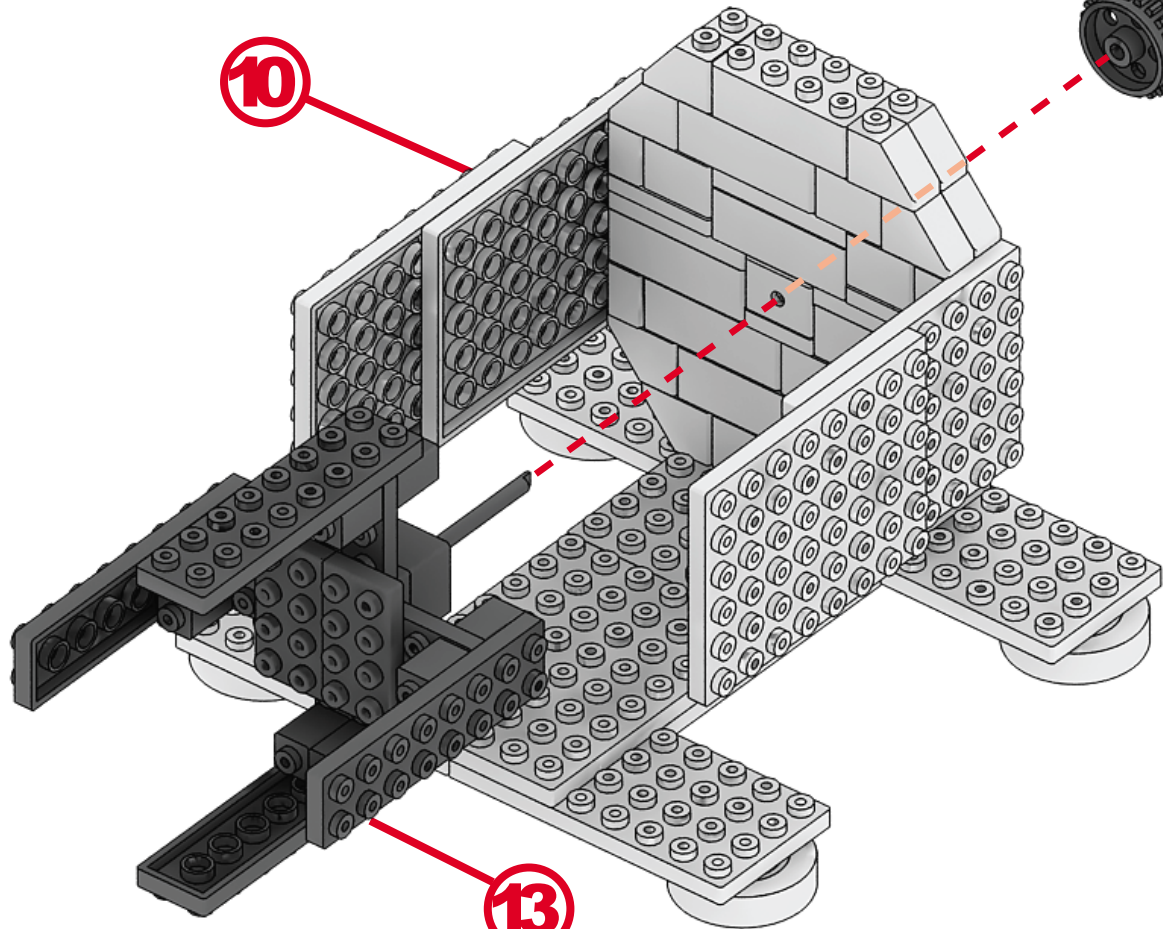

13

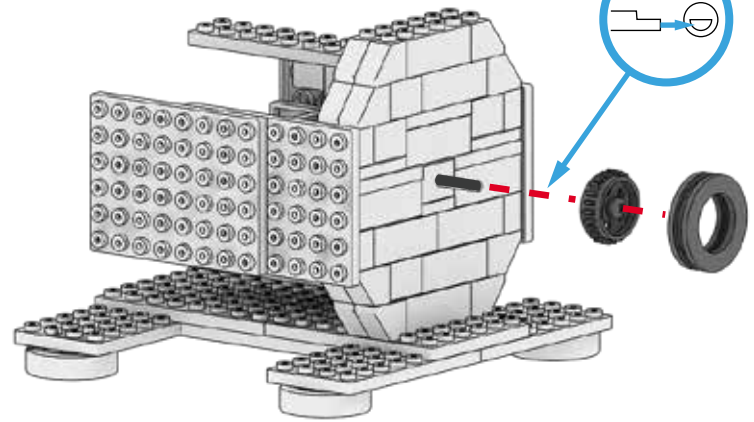
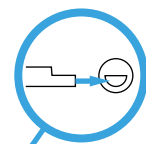
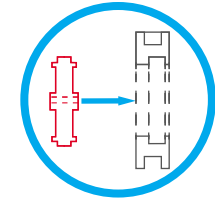
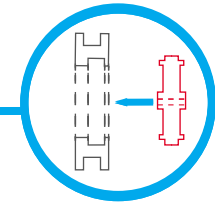

15

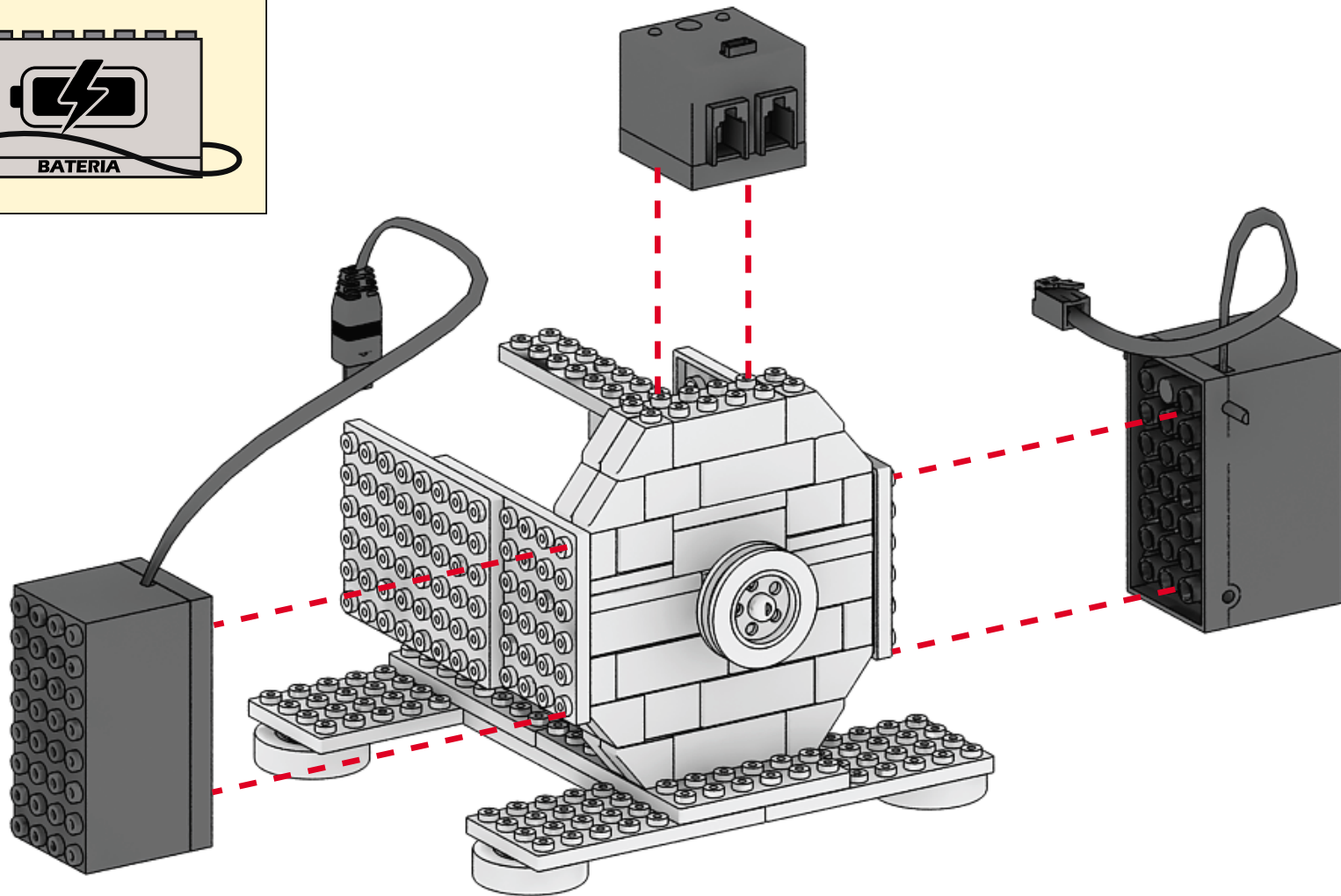
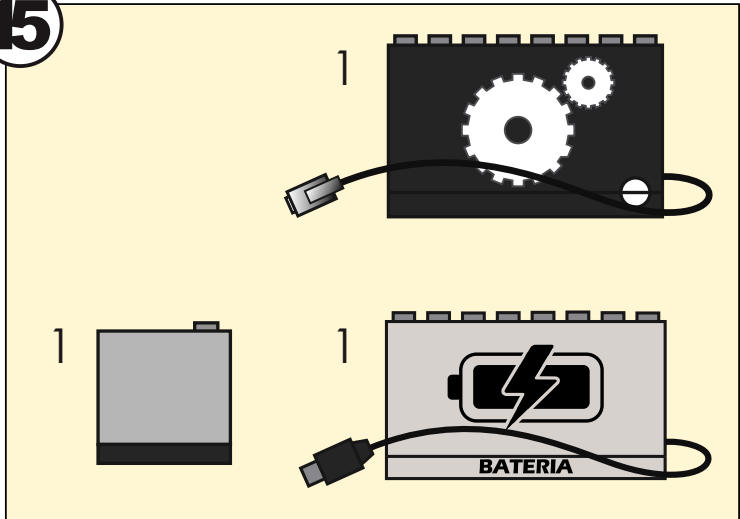

16

1

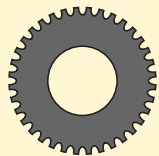

1



1

