

ROBOTICA



PROBOTS

BARCO CON
MOTOR

500 PIEZAS
+ 2 MOTORES
INTELIGENTES
Q-X4000



mis ladrillos

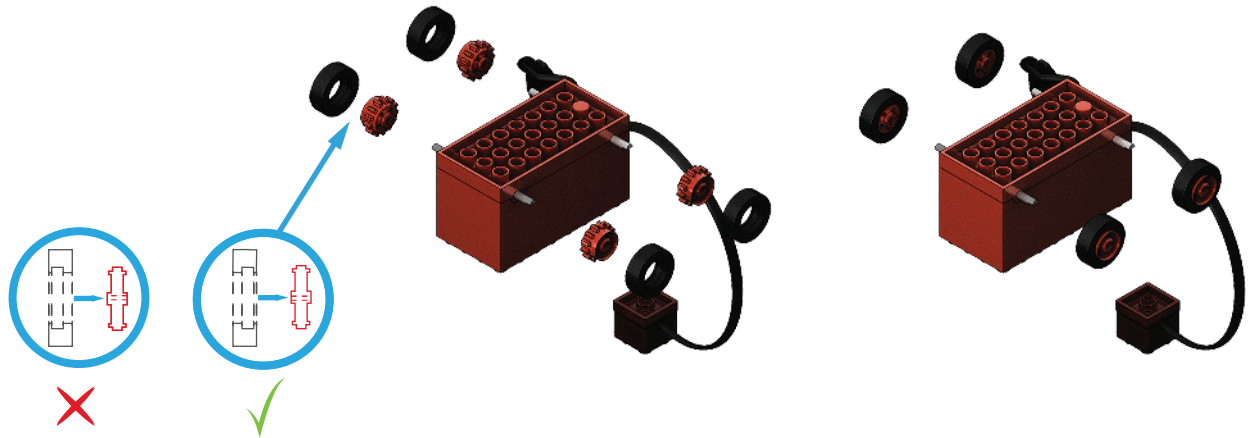
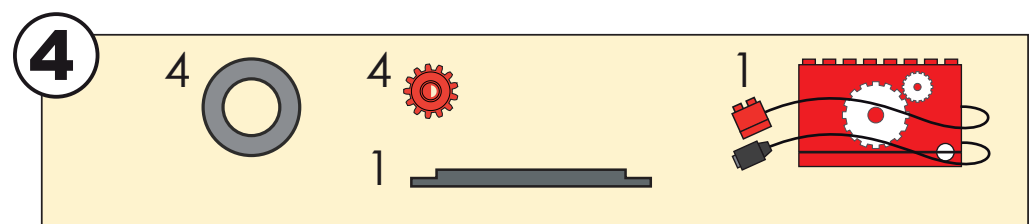
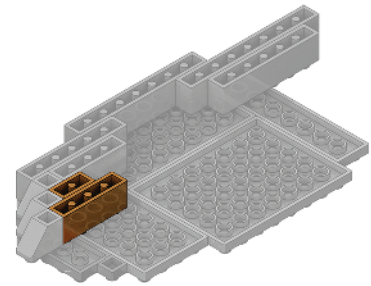
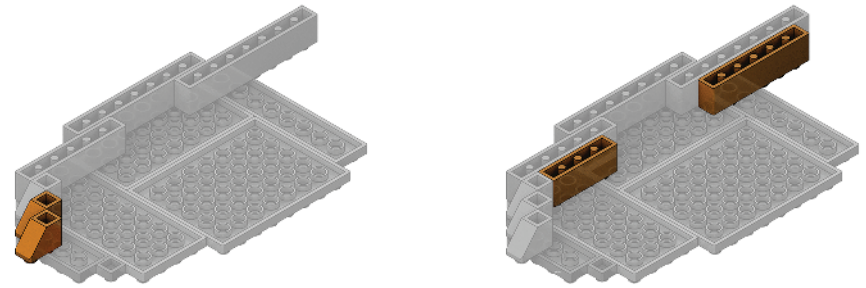
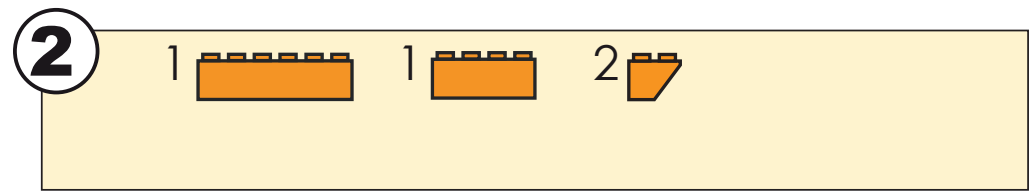
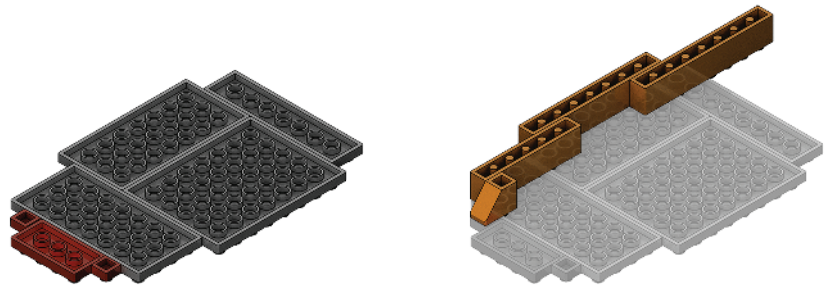
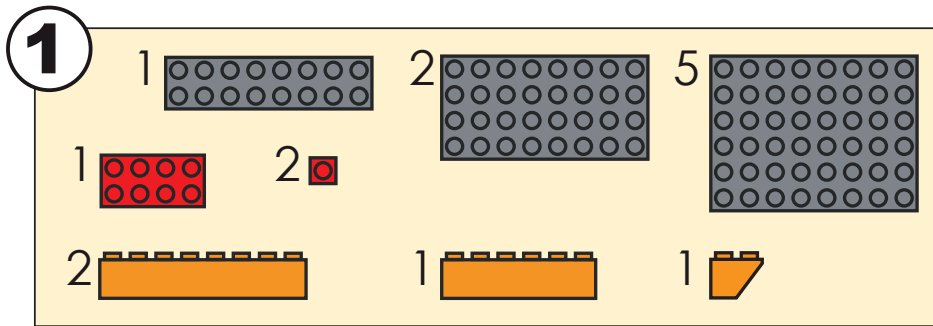

5

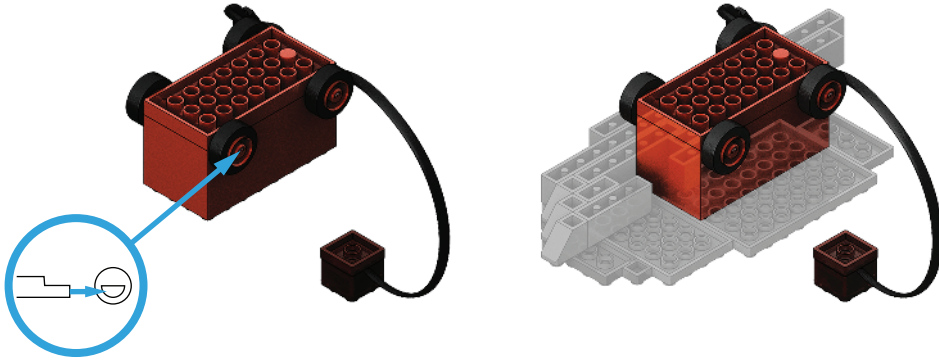

6

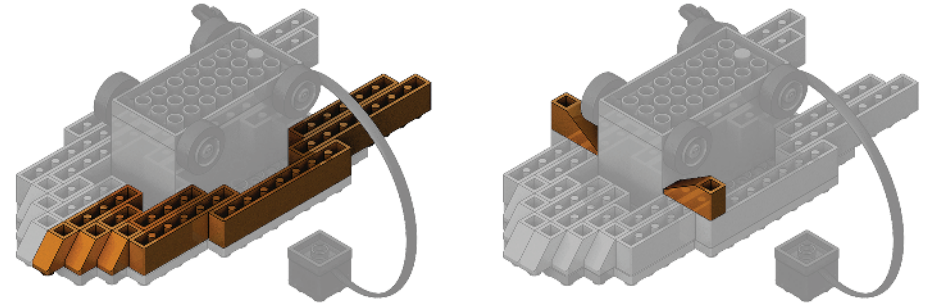
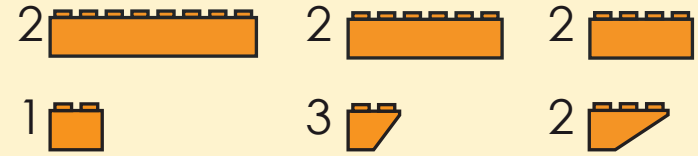

7

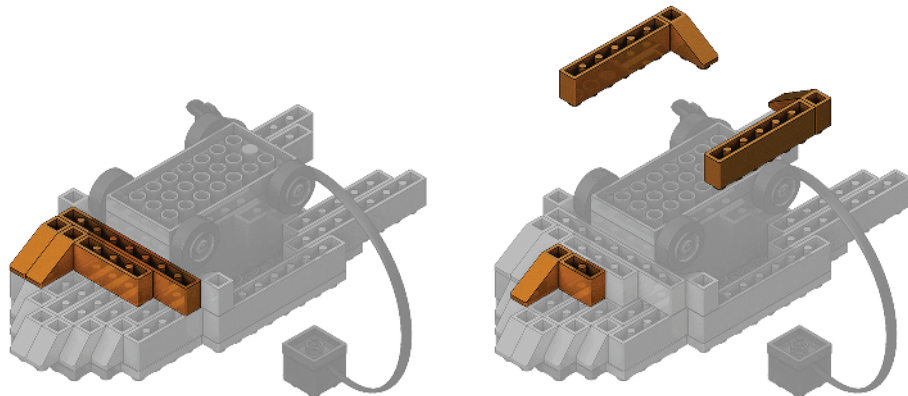
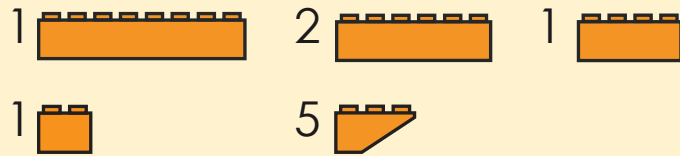

8

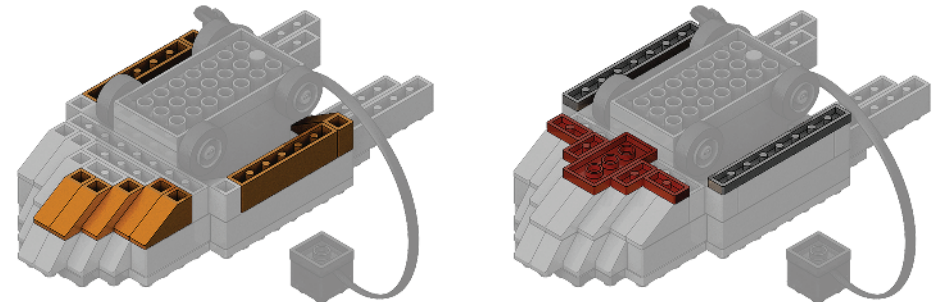
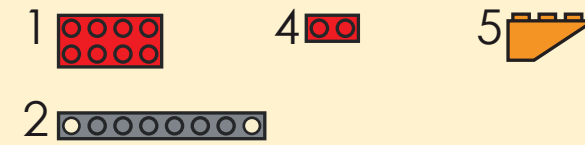

9



1

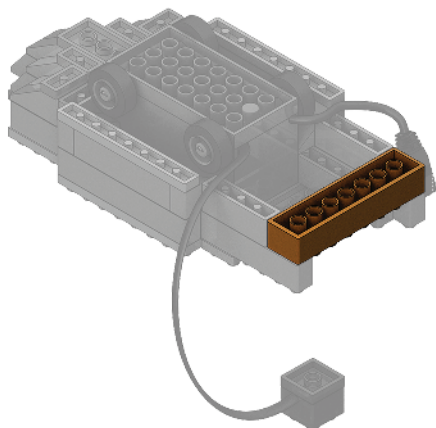
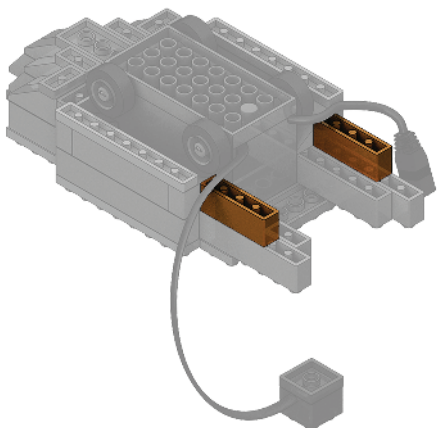
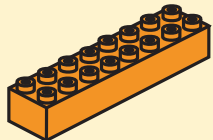

10



1



1

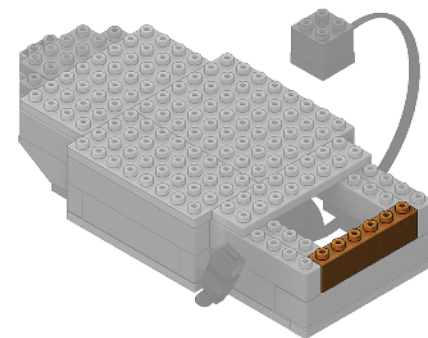
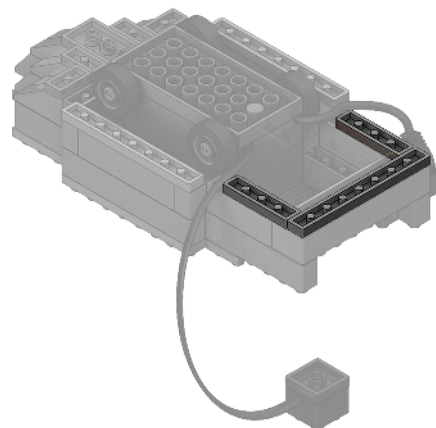

11

1

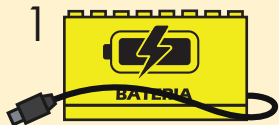

1

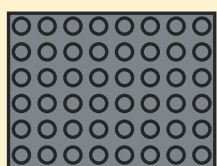

6



2



2

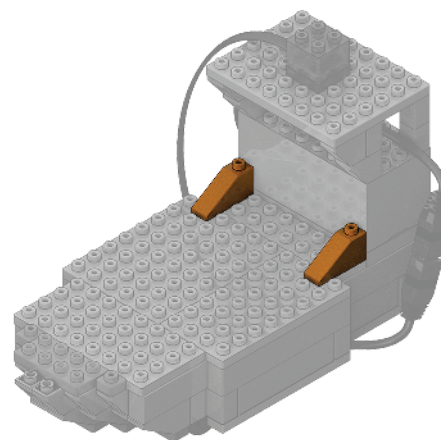
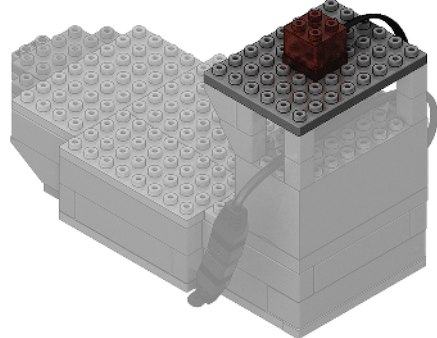
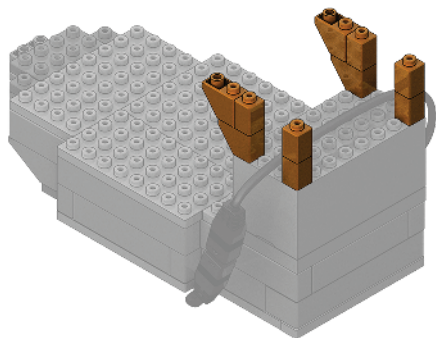
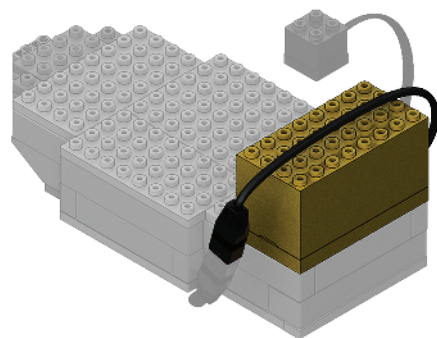

12

- 1
- 2
- 8
- 2
- 2
- 2

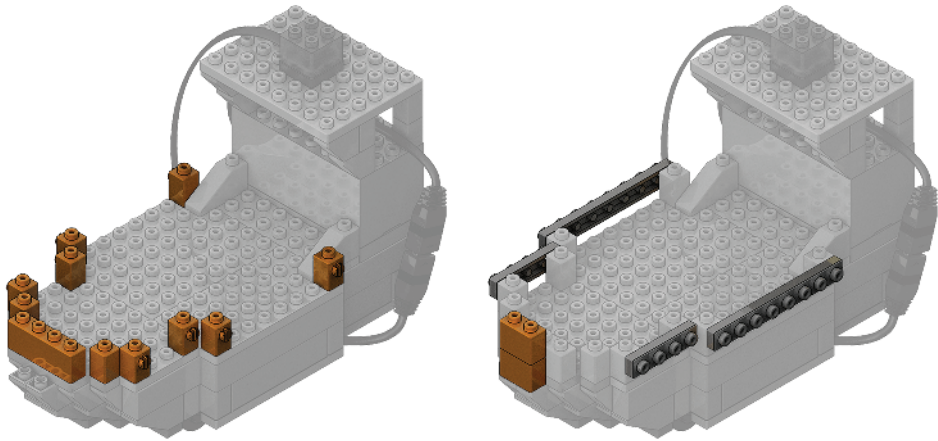

13

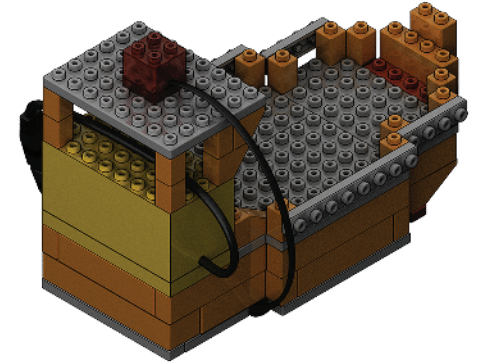
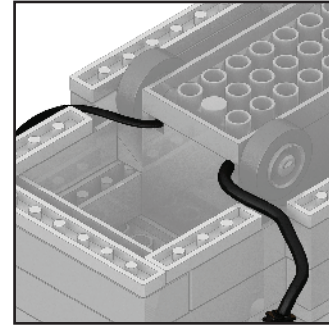

14

